

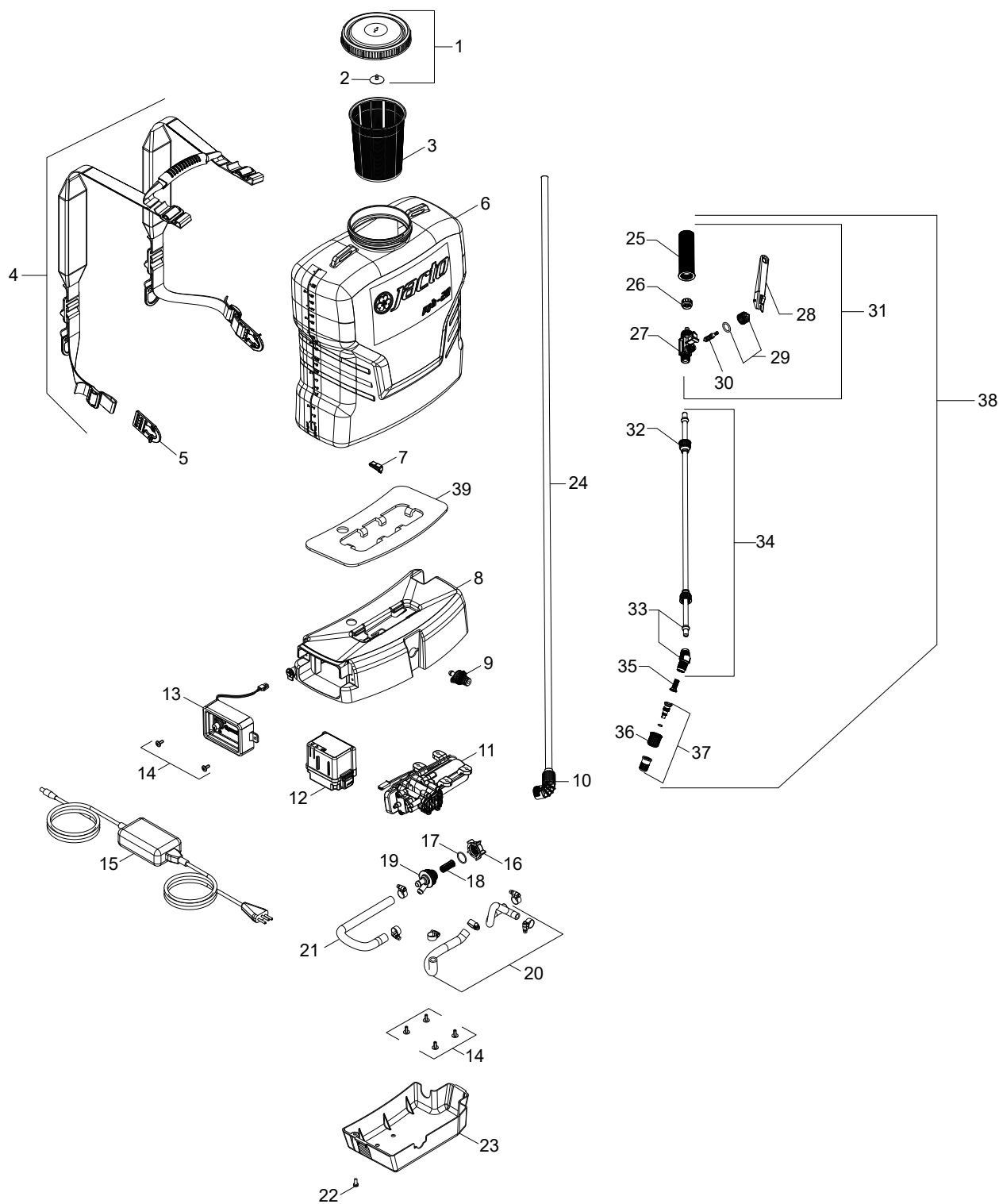

































# PARTS CATALOG





## JACTO PJB-U



Nº	CODE	DESCRIPTION	IMAGE	QTY.	UTILIZATION	NCM HS CODE	EAN BARCODE
1	1247526	LID AND DIAPHRAGM U		1	PJ-U, HD-U, PJB-U	8424.90.90	7909436906227
2	1280174	LID DIAPHRAGM U		1	PJ-U, HD-U, PJB-U	4016.99.90	7909436956420
3	1220919	TANK STRAINER		1	PJ, HD, PJB, DJB, DJB-S	8424.90.90	7896660888309
4	1220618	COMPLETE BELT WITH TRANSPORT HANDLE		1	PJB, DJB	8424.90.90	7896660888316
5	1220973	BUCKLE		1	HD, PJB, DJB, DJB-S	8424.90.90	7909436915274
6	NA	PJB-16U TANK		1	PJB-16U	8424.90.90	7909436965347
7	1168397	BASE LOCK		1	XP, PJB, DJB, DJB-S	8424.90.90	7896660888378
8	1220641	ELECTRIC SPRAYER BASE		1	PJB, DJB	8424.90.90	7896660890302
9	1279671	CONNECTION AND SEAL U		1	PJB-U	3917.40.90	7909436964159
10	1268712	QUICK CONNECTOR KIT		1	PJB (v2020), DJB (v2020)	3917.40.90	7909436938761
11	1279640	ELECTRIC PUMP U		1	PJB-U	8413.50.90	7909436964166
12	1268737	BATTERY JB 1680		1	PJB, DJB, DJB-S	4016.93.00	7909436939010
13	1268711	COMPLETE PANEL WITH POTENTIOMETER		1	PJB	4016.93.00	7909436941013
14	1220622	FLANGE HEAD SCREW PHILLIPS SLOT 5 X 12 MM		1	PJB, DJB, DJB-S	7318.15.00	7909436907286
15	1223797	PLUG TYPE A CHARGER		1	PJB, DJB	8504.40.10	7896660894140
16	1268710	FILTER LID		1	PJB (v2020)	8421.99.99	7909436938754
17	1279642	O-RING Ø 20,34 X 1,78 MM		1	PJB-U	4016.93.00	7909436964180



# JACTO PJB-U

Nº	CODE	DESCRIPTION	IMAGE	QTY.	UTILIZATION	NCM HS CODE	EAN BARCODE
18	1220634	INLINE FILTER		1	PJB, DJB, DJB-S	8421.29.19	7909436907125
19	1268713	BASE FILTER SUPPORT		1	PJB (V2020)	8424.90.90	7909436938877
20	1268692	HOSE KIT PJB		1	PJB (V2020)	3917.39.00	7909436938471
21	1268707	HOSE Ø3/8" X 300MM		1	PJB (V2020)	3917.39.00	7909436938839
22	1220947	PAN HEAD SCREW PHILLIPS SLOT M 5X0,8X12		1	PJB, DJB, DJB-S	7318.15.00	7909436907354
23	1220640	BASE COVER		1	PJB, DJB	8424.90.90	7909436906784
24	1279669	COMPLETE HOSE U		1	PJB-U	3917.39.00	7909436959186
25	1220962	TRIGGER VALVE HANDLE LP		1	PJH, PJ, HD, PJB, DJB	8424.90.90	7909436924115
26	1220966	CLIP LP 601		1	PJH, PJ, HD, PJB, DJB	3926.90.90	7909436924474
27	1220968	TRIGGER VALVE BODY LP 601		1	PJH, PJ, HD, PJB, DJB	8481.90.90	7909436924603
28	1220951	TRIGGER VALVE LEVER LP 601		1	PJH, PJ, HD, PJB, DJB	8424.90.90	7909436923989
29	1247527	TRIGGER VALVE CAP LP 601/ 605 AND SEAL U		1	PJH, PJ, HD, PJB, DJB	8481.90.90	7909436906296
30	1278246	TRIGGER VALVE NEEDLE		1	PJ-U, HD-U, PJB-U	8424.90.90	7909436962421
31	1278225	TRIGGER VALVE LP 601 U		1	PJ-U, HD-U, PJB-U	8424.90.90	7909436946889
32	1220969	SCREW CAP 11/16		1	PJH, PJ, XP, HD, PJB, DJB, DJB-S	3926.90.90	7909436924924
33	635276	JOINT AND CONE PACKING		1	PJH, PJ, XP, HD, PJB, DJB, DJB-S	3917.40.90	7909436931311
34	100131	STAINLESS STEEL LANCE		1	PJH, PJ, XP, HD, PJB, DJB	8424.90.90	7896821501252

Nº	CODE	DESCRIPTION	IMAGE	QTY.	UTILIZATION	NCM HS CODE	EAN BARCODE
35	1168545	NOZZLE FILTER M50/60		1	PJH, PJ, XP, HD, PJB, DJB, DJB-S	8424.90.90	7896660860053
36	1168546	NOZZLE CAP		1	PJH, PJ, XP, HD, PJB, DJB, DJB-S	8424.90.90	7909436925310
37	1222664	BLUE ADJUSTABLE CONE NOZZLE		1	PJH, PJ, XP, HD, PJB, DJB	8424.90.90	7909436928588
38	1247523	LANCE AND TRIGGER VALVE U		1	PJ-U, HD-U, PJB-U	8424.90.90	7909436906104
39	1269105	PJB BASE SEAL		1	PJB (V2020), DJB (V2020), PJB-U	4016.93.00	909436952583

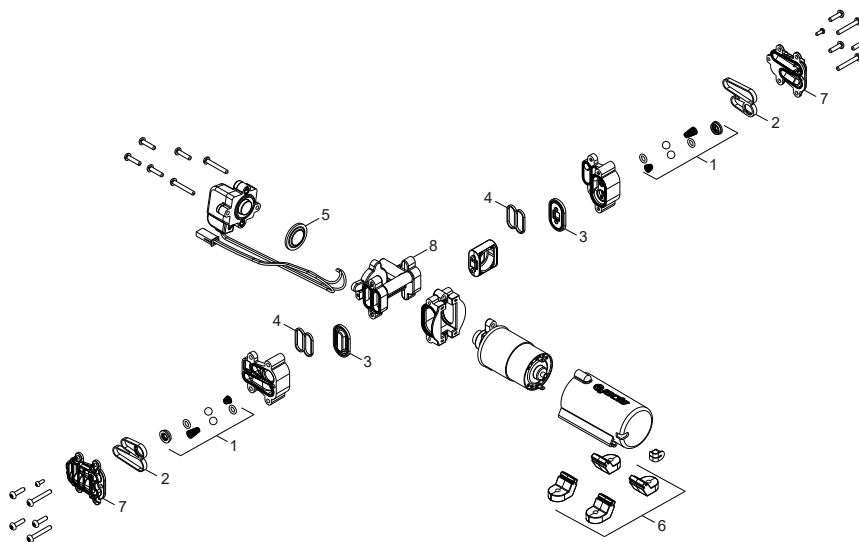
# PUMP



Nº	CODE	DESCRIPTION	IMAGE	QTY.	UTILIZATION	NCM HS CODE	EAN BARCODE
1	1279636	VALVE AND SEALS U		1	PJB-U	8481.80.95	7909436956772
2	1265948	PUMP HEAD SEAL (JEP)		1	PJB, DJB, DJB-S	3926.90.90	7909436936415
3	1279638	PUMP DIAPHRAGM U		1	PJB-U	4016.93.00	-
4	1265947	DISTRIBUTOR SEAL		1	PJB, DJB, DJB-S	3926.90.90	7909436936101
5	1265958	PRESSURE SWITCH MEMBRANE		1	PJB, DJB, DJB-S	3926.90.90	7909436936422
6	1279431	RUBBER FEET		1	PJB, DJB, DJB-S	8424.90.90	7909436952903
7	1279437	PUMP HEAD COVER (JEP)		1	PJB, DJB, DJB-S	8413.91.90	7909436953016
8	1279454	PUMP DISTRIBUTOR (JEP)		1	PJB, DJB, DJB-S	8424.90.90	7909436953023